

Round Belts

P-RB12-KG-N100 (Polycord R-12)



Applications

Live roller drive belt, Power transmission belt

Special features

Elastic, Flexibility in all directions, Monolithic Belt, Simple and fast joining method

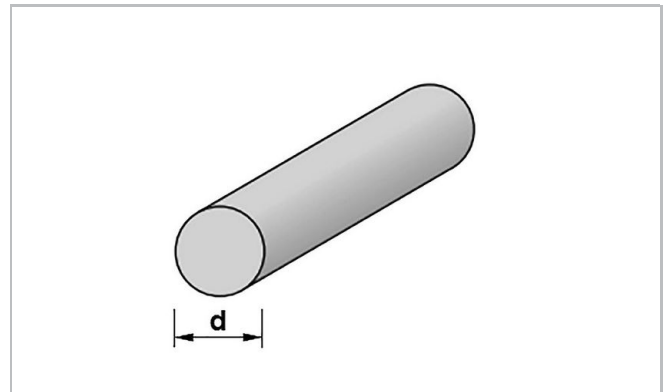
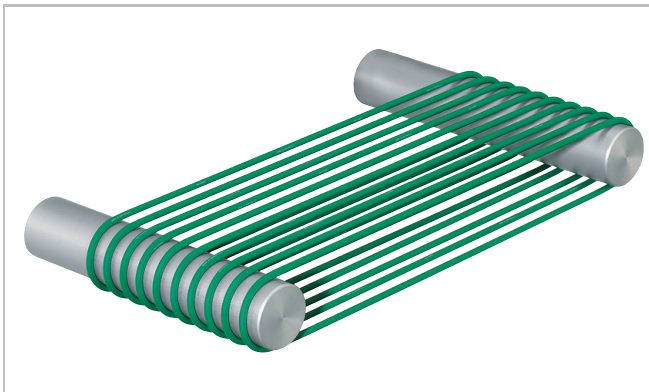

Product Construction / Design	
Friction Material	Thermoplastic polyurethane (TPU)
Friction surface structure	Sand finish
Friction cover color	Green (Habasit green)
Traction Material	Thermoplastic polyurethane (TPU)

Product characteristics	
Antistatically equipped	No
Adhesive free joining method	Yes
Food suitability, FDA conformance	No
Food suitability, EU conformance	No

Technical data			
Hardness	90	Shore A	
Diameter (d):	12	mm	0.47 inch
Weight per length:	0.136	kg/m	0.091 lbs/ft
Tensile force for 8% elongation (k8% static) (Habasit Standard SOP3-155 / EN ISO 21181):	291	N	65 lbf
Tensile force for 8% elongation after relaxation (k8% relaxed) (Habasit Standard SOP3-155 / EN ISO 21181):	212	N	48 lbf
Nominal peripheral force	372	N	84 lbf
Min. operating temperature admissible (continuous)	-20	°C	-4 °F
Max. operating temperature admissible (continuous)	50	°C	122 °F
Coefficient of friction on steel	0.40		

All data are approximate values under standard climatic conditions: 23°C/73°F, 50% relative humidity (DIN 50005/ISO 554).

Joining related properties

Joining method		Quickmelt
Pulley diameter (minimum)	mm inch	120 4.72

Round Belts

P-RB12-KG-N100 (Polycord R-12)



Chemical resistance

Link to 'Chemical resistance information': <http://www.habasit.com/en/chemical-resistance.htm>

Mode of use or conveyance

Declined, Horizontal, Inclined, Serpentine drives, Twists, Twists with short center distance

Recommendation

See Engineering Manual

For details consult 'Storage and handling requirements for belts and machine tapes' or contact Habasit, Protect belts from sunlight/UV-radiation/dust and dirt. Store spare belts in a cool and dry place and if possible in their original packaging.

This product has not been tested according to ATEX standards (atmospheres with explosion risk - ATEX 95 regulation or EU directive 94/9) and therefore is subject to user's analysis in the respective environment

Group	Extruded Belts
Sub-Group	Polycord Round Belts
Item number	H010100460

Disclaimer

Product Application Disclaimer (valid for ALL Habasit products and mentioned on all PDS)

This disclaimer is made by and on behalf of Habasit and its affiliated companies, directors, employees, agents and contractors (hereinafter collectively "HABASIT") with respect to the products referred to herein (the "Products"). SAFETY WARNINGS SHOULD BE READ CAREFULLY AND ANY RECOMMENDED SAFETY PRECAUTIONS BE FOLLOWED STRICTLY! Please refer to the Safety Warnings herein, in the Habasit catalogue as well as installation and operating manuals. All indications / information as to the application, use and performance of the Products are recommendations provided with due diligence and care, but no representations or warranties of any kind are made as to their completeness, accuracy or suitability for a particular purpose. The data provided herein are based on laboratory application with small-scale test equipment, running at standard conditions, and do not necessarily match product performance in industrial use. New knowledge and experience may lead to re-assessments and modifications within a short period of time and without prior notice. EXCEPT AS EXPLICITLY WARRANTED BY HABASIT, WHICH WARRANTIES ARE EXCLUSIVE AND IN LIEU OF ALL OTHER WARRANTIES, EXPRESS OR IMPLIED, THE PRODUCTS ARE PROVIDED "AS IS". HABASIT DISCLAIMS ALL OTHER WARRANTIES, EITHER EXPRESS OR IMPLIED, INCLUDING, BUT NOT LIMITED TO, IMPLIED WARRANTIES OF MERCHANTABILITY, FITNESS FOR A PARTICULAR PURPOSE, NON-INFRINGEMENT, OR ARISING FROM A COURSE OF DEALING, USAGE, OR TRADE PRACTICE, ALL OF WHICH ARE HEREBY EXCLUDED TO THE EXTENT ALLOWED BY APPLICABLE LAW. BECAUSE CONDITIONS OF USE IN INDUSTRIAL APPLICATION ARE OUTSIDE OF HABASIT'S CONTROL, HABASIT DOES NOT ASSUME ANY LIABILITY CONCERNING THE SUITABILITY AND PROCESS ABILITY OF THE PRODUCTS, INCLUDING INDICATIONS ON PROCESS RESULTS AND OUTPUT.